

VZ3184R IR-MP PZFI

【SPECIFICATIONS】 2.7X motorized zoom lens for 4Mega-Pixel

Image Size : 1

Focal Length : 31~84mm
 Maximum Relative Aperture : 1:2.6
 Iris : F2.6~Close (No F drop)
 Zoom Ratio : 2.7X
 Angle of View : 23.6×17.7 deg. at 31mm
 8.7× 6.5 deg. at 84mm
 Image Size : 12.8×9.6mm(φ16mm)
 Minimum Object Distance : 7m(From Front Vertex)
 Resolution : Corresponding to 5.5μm
 Optical Back Focal Distance : 23.29mm(In Air)
 Frange Back : 17.526mm

Flange Back : 17.526mm
 Operation : Zoom : Motorized (DC±6.4V, Max45mA)
 Potentiometer : 5kΩ
 Focus : Motorized (DC±6.4V, Max45mA)
 Potentiometer : 5kΩ
 Iris : Motorized (DC±6.4V, Max45mA)
 Potentiometer : 5kΩ
 Operating Temperature : -10~+50°C
 Mount : C-Mount (Adjustable Lens Position)
 Filter Size : 62mm P0.75
 Size : 80×80.5×114.8mm
 Weight : Approx. 710g

【COMPOSITION】

- Lens.....1
- Lens Cap.....1
- Dust Cap.....1

【DIMENSIONS】

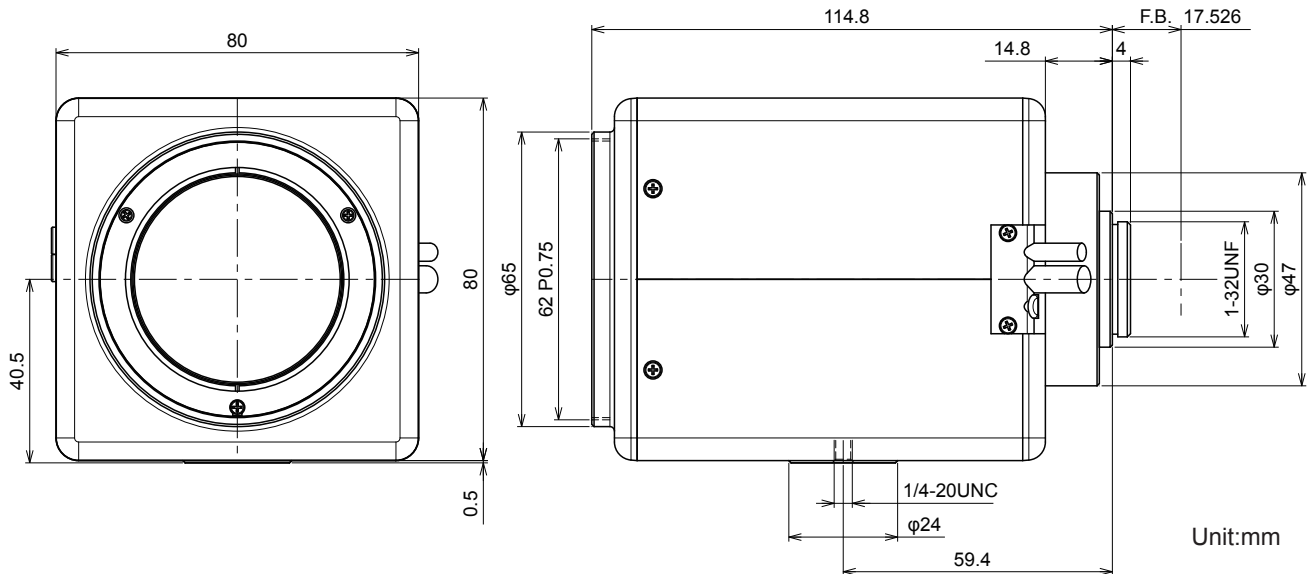

【CIRCUIT DIAGRAM】

